

R.8LA | R.LA 1/4" long-reach metric 6-point sockets





Standards:

NF ISO 2725-1, NF ISO 1711-1,
ISO 2725-1, ISO 1711-1, DIN
3124, ASME B107.5

Description:

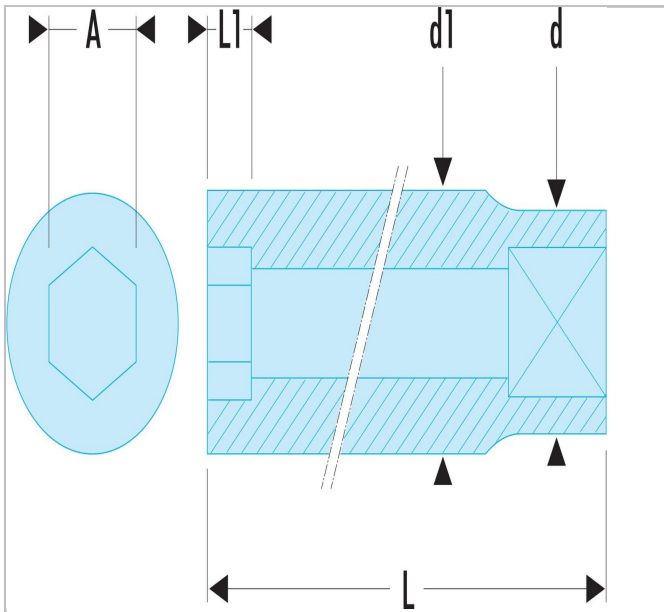
- OGV® profile: more powerful tightening, preserves fasteners.
- Long-reach sockets for long recess or thread access.
- Available as rack set Ref RL.40E (3.2 --> 9 mm) and Ref RL.41E (10 --> 14 mm).
- Finish: bright chrome.



	R.8LA
A [mm]	0.3
Diameter [mm]	12.0
Diameter D1 [mm]	12.0
Length L [mm]	50.5
Length L1 [mm]	7.9
Hex Size [mm]	6.0
Weight [Kg]	0.027