

R.9 | R 1/4" drive metric 6-point sockets





Standards:

NF ISO 2725-1, NF ISO 1711-1,
ISO 2725-1, ISO 1711-1, DIN
3124, ASME B107.5

Description:

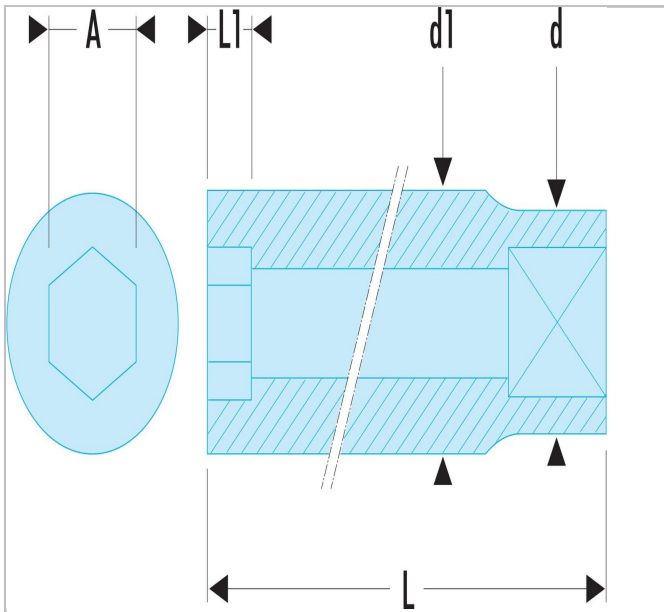
- OGV® profile: more powerful tightening, preserves fasteners.
- Finish: bright chrome.
- Available as sets on metal rack (Ref R.40E).



	R.9
A [mm]	9.0
Diameter [mm]	13.2
Diameter D1 [mm]	13.2
Length L [mm]	22.0
Length L1 [mm]	6.5
Height H3 [mm]	6.5