

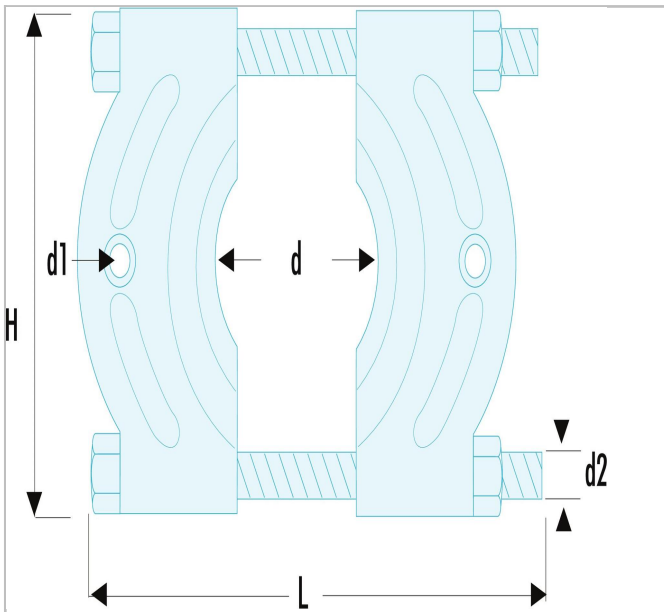

## U.53T1 | U.53T - Separators



### Description:

- Separators spread  $\varnothing$  5 to 250 mm.
- Fit behind races where ordinary puller claws will not reach.
- They can be used with beams assisted by screws or jacks.



	<b>U.53T1</b>
Diameter D Mini - Maxi [mm]	5 - 60
Diameter D1 [mm]	M10
Diameter D2 [mm]	M12
Length L [mm]	140.0
Height H [mm]	91.0
Screw Size ["]	U.53T1-02
Weight [Kg]	0.6