

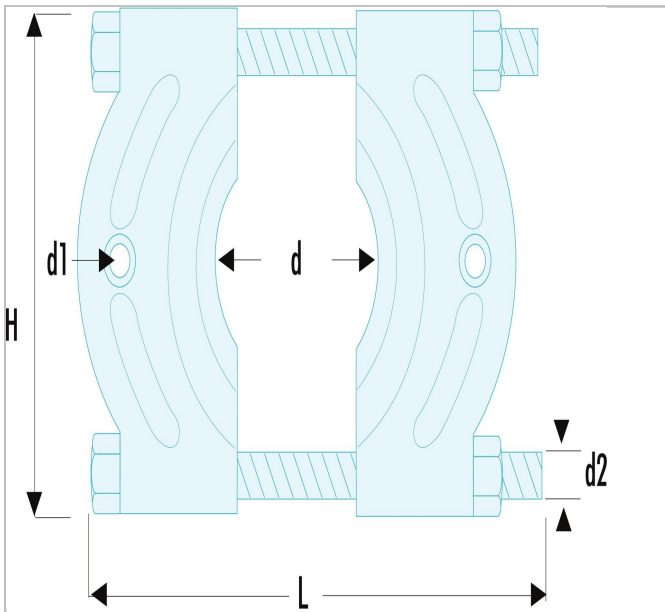

U.53T4 | U.53T - Separators



Description:

- Separators spread \varnothing 5 to 250 mm.
- Fit behind races where ordinary puller claws will not reach.
- They can be used with beams assisted by screws or jacks.



	U.53T4
Diameter D Mini - Maxi [mm]	20 - 180
Diameter D1 [mm]	M22
Diameter D2 [mm]	M22
Length L [mm]	360.0
Height H [mm]	289.0
Screw Size ["]	U.53T4-02
Weight [Kg]	8.2