

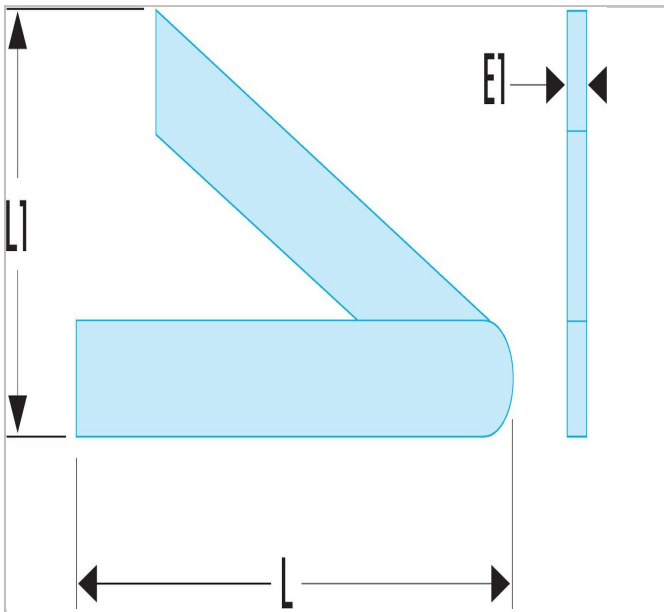

817.25 | 817 - Dummy squares



Description:

- Surface and edges in ground steel.



	817.25
Thickness E1 [mm]	15.0
Weight [g]	300.0
Length L1 [mm]	24 - 240