

985917 | Hexagonal crimping dies



Standards:

NFC 20-130

Description:

- For crimping pliers 985913.
- For tubular terminals and sleeves.

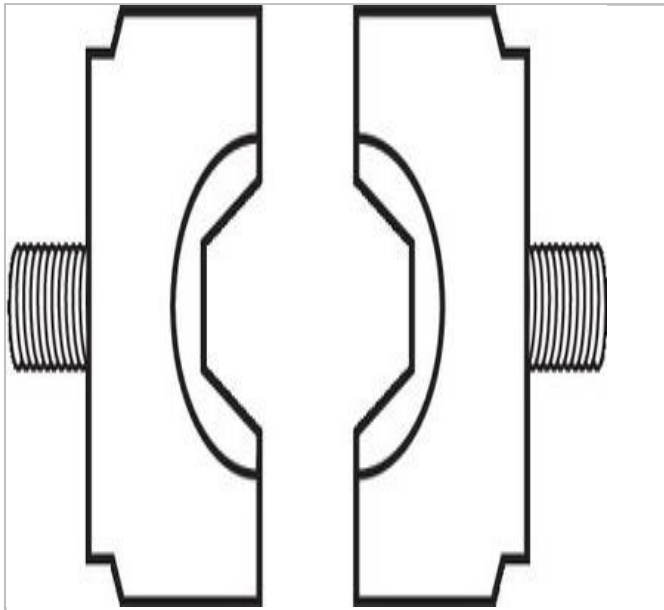

	985917
Weight [g]	89.0