

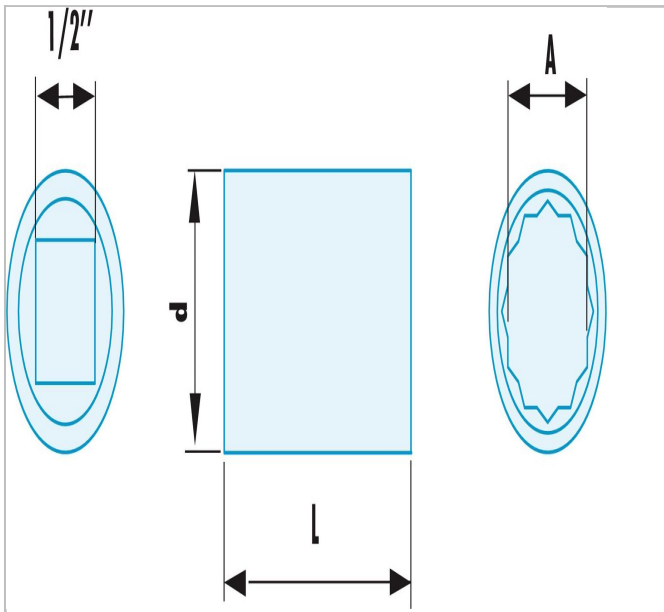

S.22SR | Non sparking 1/2" metric 12-point sockets



Description:

- Special non sparking and anti-magnetic Copper-Beryllium alloy.



 S.22SR	
A [mm]	22.0
Diameter D Maxi [mm]	31.0
Length L [mm]	43.0
Weight [g]	145.0