

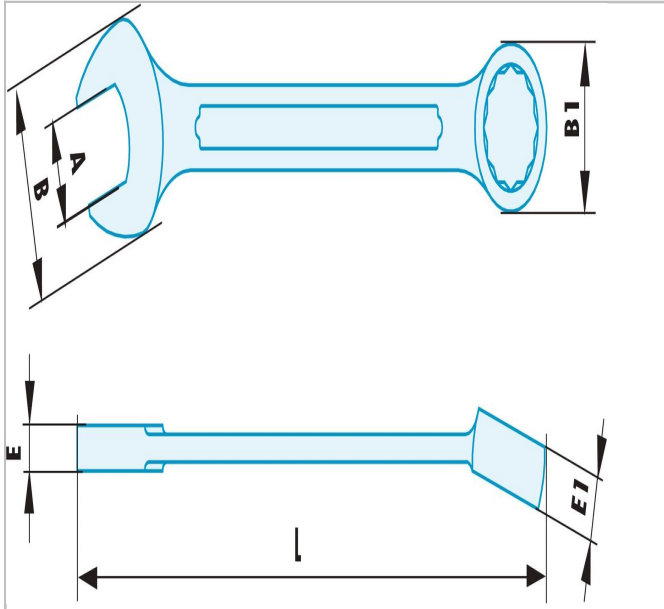

440.7SR | 440.SR - Non sparking metric combination wrenches



Description:

- Special non sparking and anti-magnetic Copper-Beryllium alloy.



	440.7SR
A [mm]	7.0
Length L [mm]	120.0
Thickness E [mm]	5.0
Thickness E1 [mm]	7.0
Head Width B [mm]	17.5
Head Width B1 [mm]	14.5
Weight [g]	25.0