

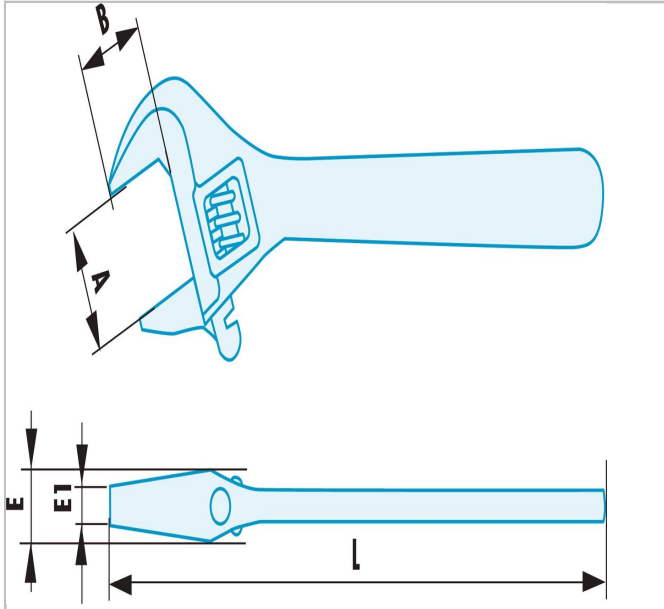

## 113A.8SR | 113A.SR - Non sparking adjustable wrenches



### Description:

- Special non sparking and anti-magnetic Copper-Beryllium alloy.



 FACOM	113A.8SR
A [mm]	24.0
Length L [mm]	200.0
Thickness E [mm]	13.3
Thickness E1 [mm]	9.0
Head Width B [mm]	24.0
Weight [g]	280.0