

NM.38LA | NM.LA - 1" drive long-reach metric 6-point impact sockets



Standards:

NF ISO 2725-2, NF ISO 1711-2,
ISO 2725-2, ISO 1711-2, DIN
3129, ASME B107.33

Description:

- For your safety, use impact sockets and accessories with the appropriate rings and pins.

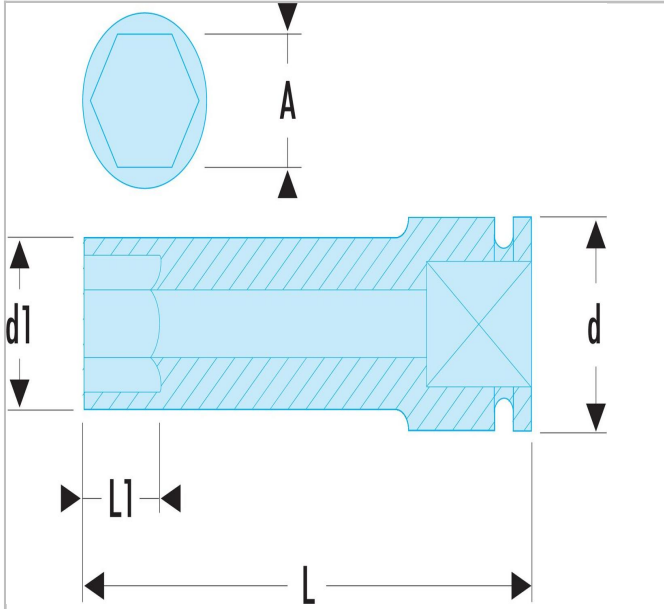



NM.38LA