

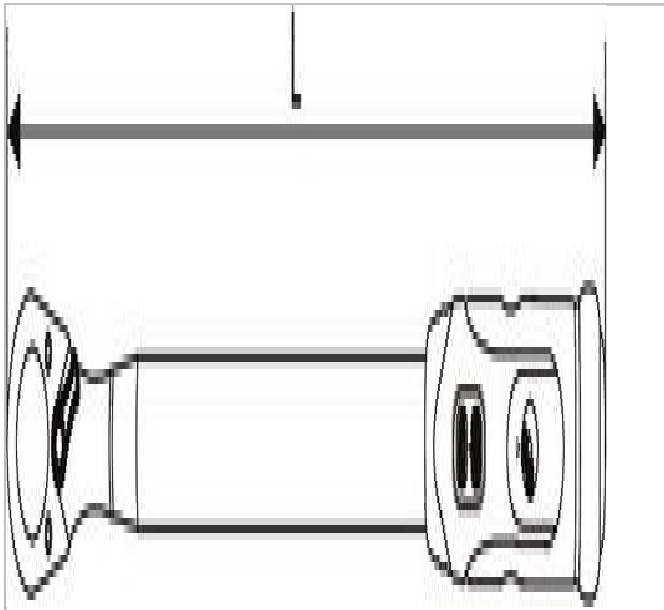

E100105 | EXPERT Torque wrenches



Description:

- ISO 6789
- Accuracy: +/4%.
- Comfortable grip.
- Direct torque value reading.
- Fast and easy setting.
- Supplied with calibration certificate.



	E100105
Length L [mm]	323.0
Weight [g]	760.0
Torque [Nm]	5 - 25
No. []	1/4