

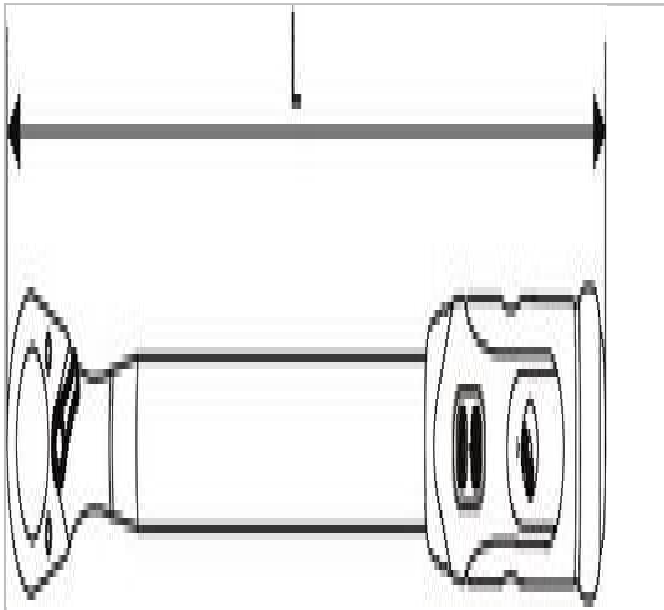

E100107 | EXPERT Torque wrenches



Description:

- ISO 6789
- Accuracy: +/4%.
- Comfortable grip.
- Direct torque value reading.
- Fast and easy setting.
- Supplied with calibration certificate.



	E100107
Length L [mm]	400.0
Weight [g]	988.0
Torque [Nm]	20 - 100
No. []	1/2