

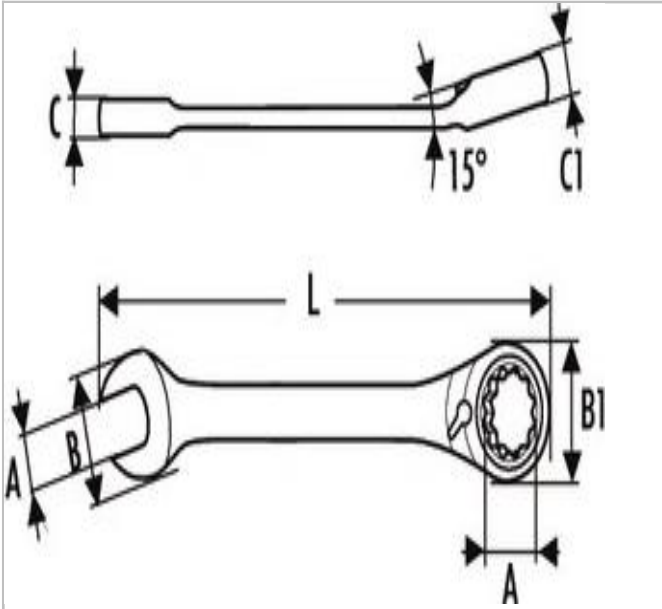

E113306 | EXPERT Ratchet combination wrenches - Metric



Description:

- ISO 691
- ISO 1711-1
- 5° increment.
- 12-point ring angled at 15°.
- Open end angled at 15° from the handle axis (increment angle 30°).
- Switch to change ratcheting direction built into handle to prevent accidental change.
- Forged in Chrome Vanadium steel.
- High chrome finish.



	E113306
A [mm]	14
Length L [mm]	189.0
Head Height C [mm]	7.5
Head Width B [mm]	31.5
Head Width B1 [mm]	27.7
Weight [Kg]	0.116