

E113206 | EXPERT Combination wrenches - Metric

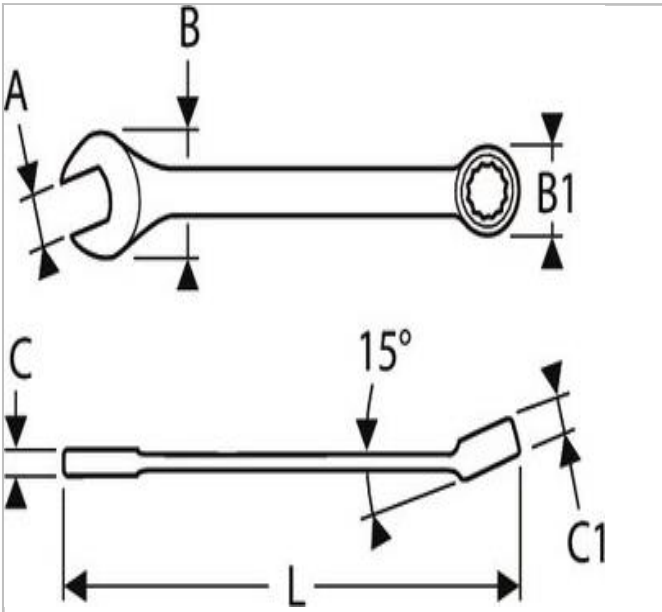

Description:

- ISO 691
- ISO 1711-1
- ISO 3318
- ISO 7738
- DIN 3113
- 12-point OGV® ring angled at 15°.
- Open end angled at 15° from handle axis.
- OGV® profile maximizing the contact surface with the nut for a longer lifetime.
- Forged in Chrome Vanadium steel.
- High chrome finish.



	E113206
A [mm]	11
Length L [mm]	150.0
Thickness E1 [mm]	4.7
Thickness E2 [mm]	6.5
Head Width B [mm]	25.7
Head Width B1 [mm]	17.0
Weight [Kg]	0.045
Head Height C [mm]	4,7
Head Height C1 [mm]	6.5