

E113358 | EXPERT Combination wrenches - Inch

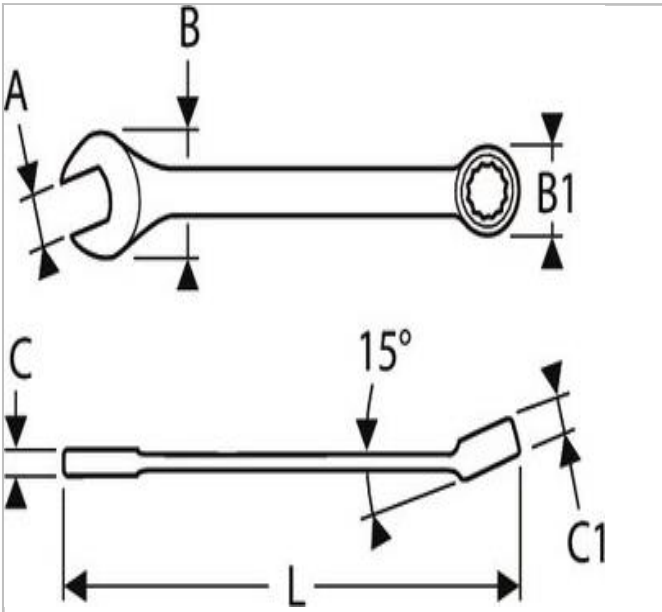

Description:

- ASME B 107-100
- 12-point OGV® ring angled at 15°.
- Open end angled at 15° from handle axis.
- OGV® profile maximizing the contact surface with the nut for a longer lifetime.
- Forged in Chrome Vanadium steel.
- High chrome finish.



	E113358
A [in]	3/4"
Length L [mm]	230.0
Thickness E1 [mm]	7.1
Thickness E2 [mm]	10.3
Head Width B [mm]	42.2
Head Width B1 [mm]	29.0
Weight [Kg]	0.15
Head Height C [mm]	7,1
Head Height C1 [mm]	10.4