

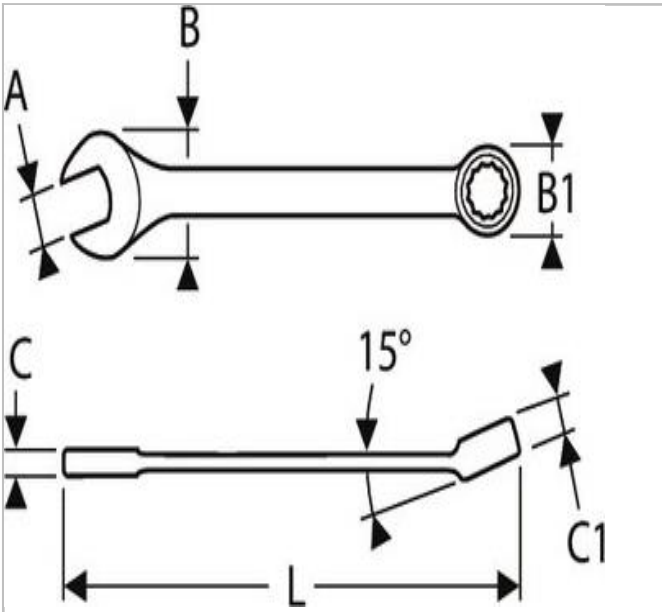

E113315 | EXPERT Combination wrenches - Inch



Description:

- ASME B 107-100
- 12-point OGV® ring angled at 15°.
- Open end angled at 15° from handle axis.
- OGV® profile maximizing the contact surface with the nut for a longer lifetime.
- Forged in Chrome Vanadium steel.
- High chrome finish.



	E113315
A [in]	7/16"
Length L [mm]	150.0
Thickness E1 [mm]	4.7
Thickness E2 [mm]	6.5
Head Width B [mm]	25.7
Head Width B1 [mm]	17.0
Weight [Kg]	0.046
Head Height C [mm]	4,7
Head Height C1 [mm]	6.5