

E117388 | EXPERT 6 x 6 point flare nut wrenches

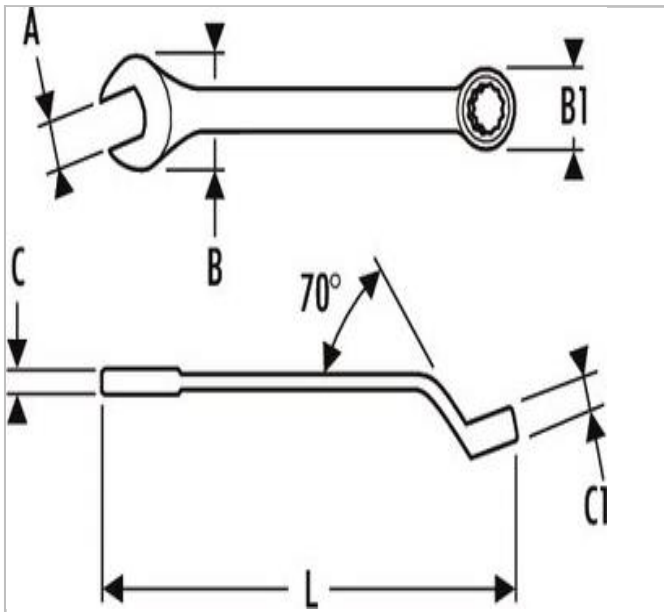

Description:

- DIN 3118
- ISO 691
- 12-point OGV® ring angled at 15°.
- Open end angled at 15° from handle axis.
- 6-point heads up to 12 x 14 mm.
- Forged in Chrome Vanadium steel.
- High chrome finish.



	E117388
A [in]	8
Length L [mm]	139.0
Head Height C [mm]	6.5
Head Height C1 [mm]	7.5
Head Width B [mm]	17.8
Head Width B1 [mm]	19.3
Weight [mm]	0.041
Diameter [mm]	6.0
Diameter D1 [mm]	7.0