

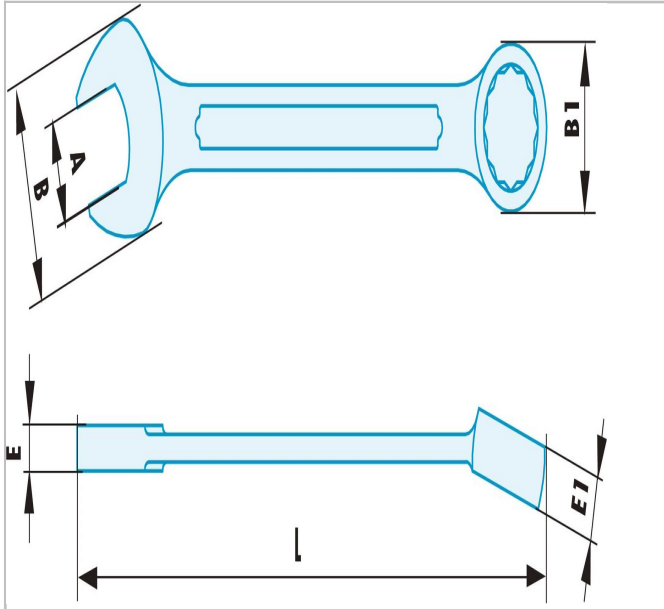

440.21SR | 440.SR - Non sparking metric combination wrenches



Description:

- Special non sparking and anti-magnetic Copper-Beryllium alloy.



	440.21SR
A [mm]	21.0
Length L [mm]	230.0
Thickness E [mm]	9.5
Thickness E1 [mm]	13.5
Head Width B [mm]	45.0
Head Width B1 [mm]	34.0
Weight [g]	225.0