

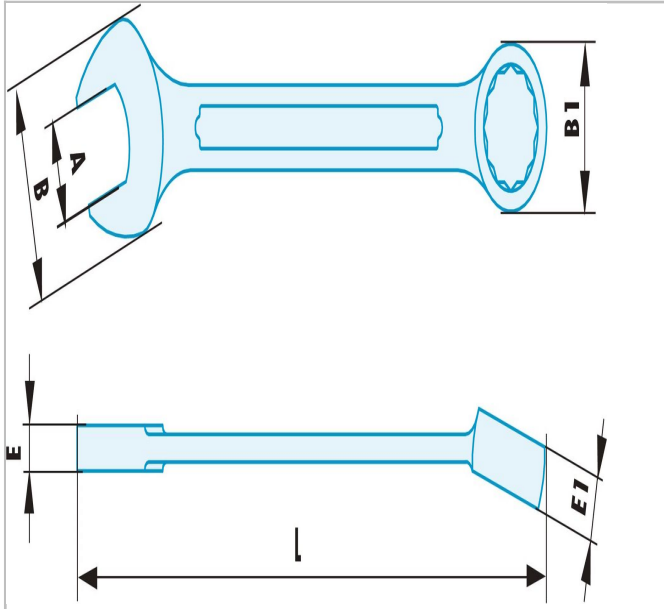

440.19SR | 440.SR - Non sparking metric combination wrenches



Description:

- Special non sparking and anti-magnetic Copper-Beryllium alloy.



	440.19SR
A [mm]	19.0
Length L [mm]	215.0
Thickness E [mm]	8.0
Thickness E1 [mm]	12.0
Head Width B [mm]	39.0
Head Width B1 [mm]	31.0
Weight [g]	210.0