

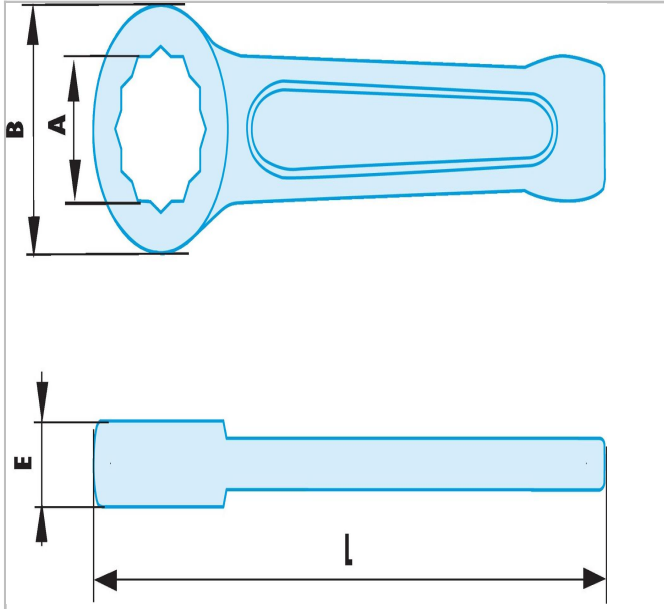

50.55SR | 50.SR - Non sparking metric impact ring wrenches



Description:

- Special non sparking and anti-magnetic Copper-Beryllium alloy.



 50.55SR	
A [mm]	55.0
Length L [mm]	265.0
Thickness E [mm]	23.5
Head Width B [mm]	86.0
Weight [g]	1400.0