

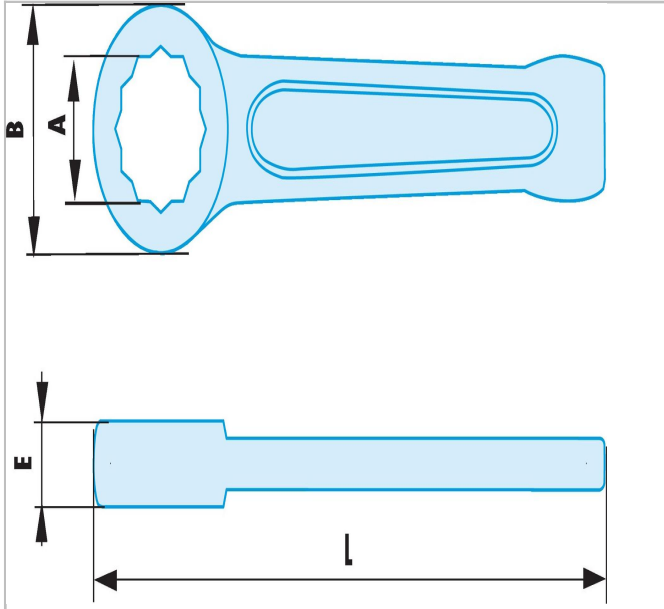

50.24SR | 50.SR - Non sparking metric impact ring wrenches



Description:

- Special non sparking and anti-magnetic Copper-Beryllium alloy.



	50.24SR
A [mm]	24.0
Length L [mm]	165.0
Thickness E [mm]	14.0
Head Width B [mm]	42.0
Weight [g]	235.0