

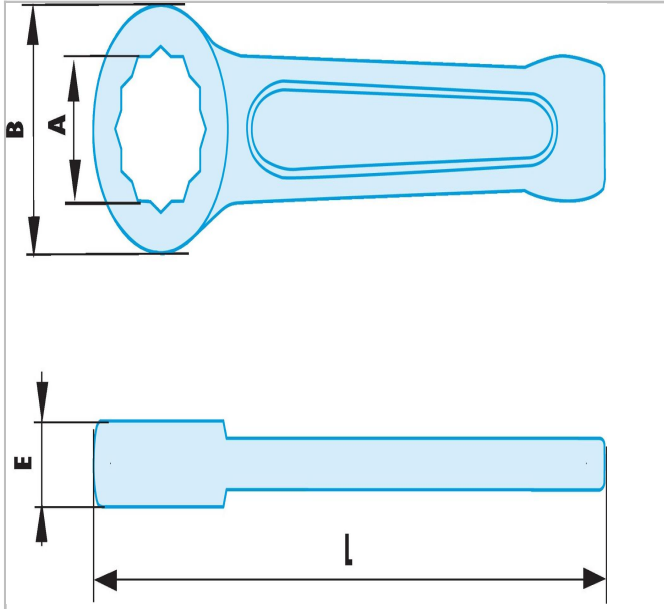

50.19SR | 50.SR - Non sparking metric impact ring wrenches



Description:

- Special non sparking and anti-magnetic Copper-Beryllium alloy.



	50.19SR
A [mm]	19.0
Length L [mm]	145.0
Thickness E [mm]	12.0
Head Width B [mm]	32.0
Weight [g]	200.0