

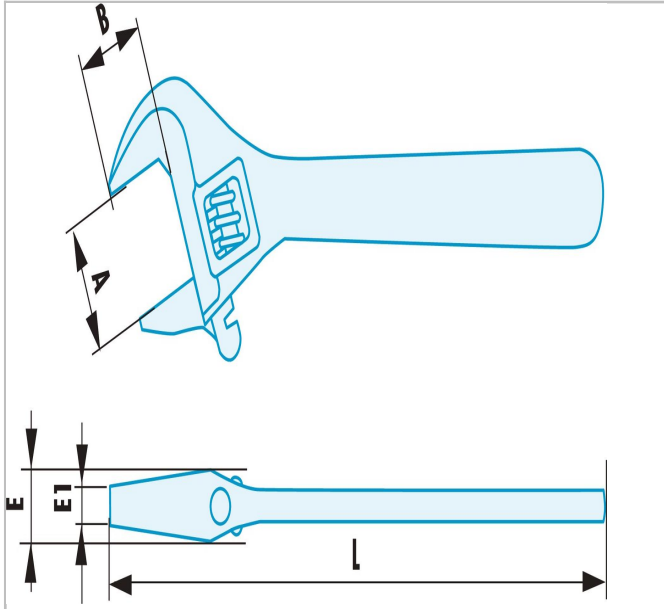

## 113A.18SR | 113A.SR - Non sparking adjustable wrenches



### Description:

- Special non sparking and anti-magnetic Copper-Beryllium alloy.



 FACOM	113A.18SR
A [mm]	55.0
Length L [mm]	450.0
Thickness E [mm]	26.7
Thickness E1 [mm]	15.0
Head Width B [mm]	51.0
Weight [g]	2300.0