

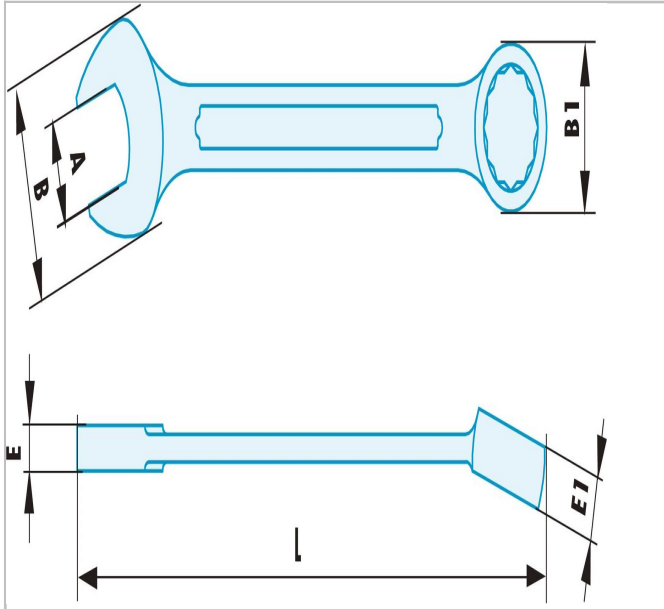

440.11SR | 440.SR - Non sparking metric combination wrenches



Description:

- Special non sparking and anti-magnetic Copper-Beryllium alloy.



	440.11SR
A [mm]	11.0
Length L [mm]	150.0
Thickness E [mm]	6.0
Thickness E1 [mm]	9.0
Head Width B [mm]	26.5
Head Width B1 [mm]	21.0
Weight [g]	55.0