

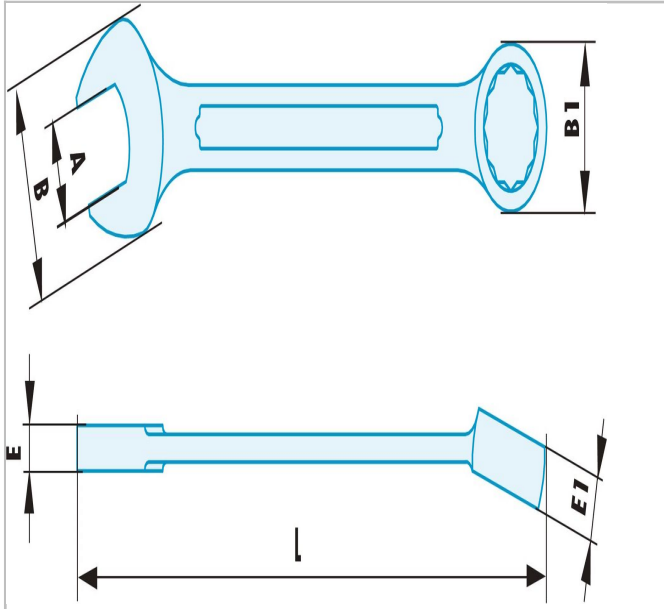

440.17SR | 440.SR - Non sparking metric combination wrenches



Description:

- Special non sparking and anti-magnetic Copper-Beryllium alloy.



	440.17SR
A [mm]	17.0
Length L [mm]	195.0
Thickness E [mm]	7.6
Thickness E1 [mm]	11.0
Head Width B [mm]	35.0
Head Width B1 [mm]	27.0
Weight [g]	155.0