

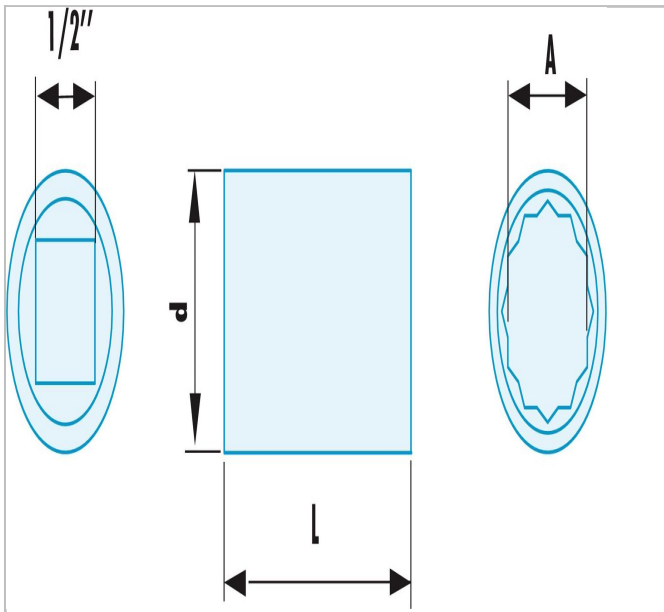

S.27SR | Non sparking 1/2" metric 12-point sockets



Description:

- Special non sparking and anti-magnetic Copper-Beryllium alloy.



 S.27SR	
A [mm]	27.0
Diameter D Maxi [mm]	38.0
Length L [mm]	46.0
Weight [g]	235.0