

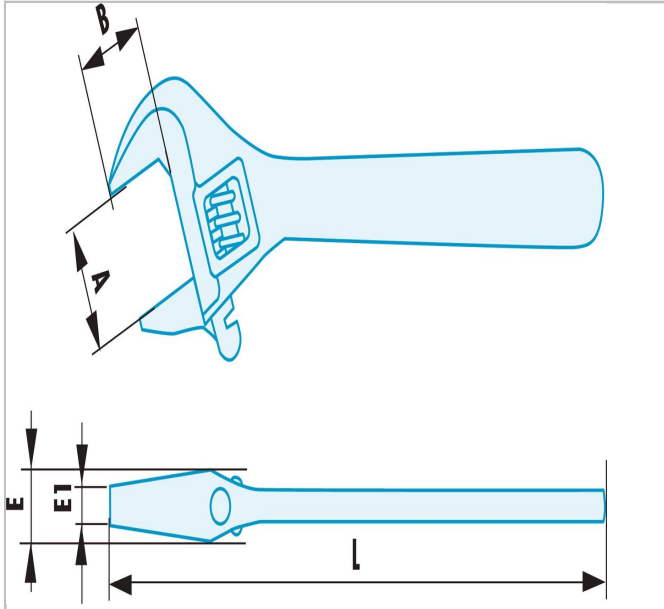

## 113A.10SR | 113A.SR - Non sparking adjustable wrenches



### Description:

- Special non sparking and anti-magnetic Copper-Beryllium alloy.



	<b>113A.10SR</b>
A [mm]	30.0
Length L [mm]	250.0
Thickness E [mm]	15.7
Thickness E1 [mm]	10.6
Head Width B [mm]	28.0
Weight [g]	440.0