

55A.27X29 | 55A - Metric offset-ring wrenches





Standards:

NF ISO 1711-1, NF ISO 691, ISO 1711-1, ISO 691, DIN 838, DIN ISO 1711-1, DIN ISO 691

Description:

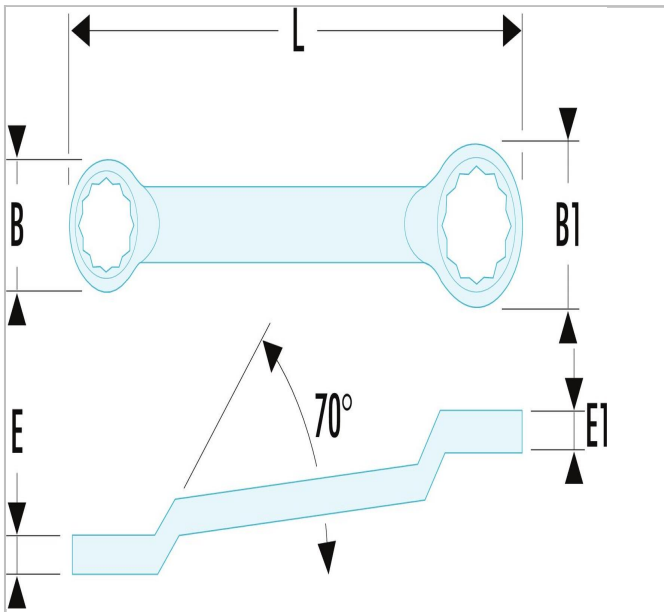
- Offset-ring wrenches: ring offset to clear fingers or obstacles. Ideal for series of nuts.
- OGV® profile with 12-point profile for powerful tightening while protecting the nut.
- Metric sizes: 6 to 50 mm.
- Presentation: satin chrome finish.



	55A.27X29
A [mm]	27x29
Length L [mm]	353.0
Thickness E [mm]	14.3
Thickness E1 [mm]	15.7
Head Width B [mm]	41.5
Head Width B1 [mm]	46.0