

55A.8X10 | 55A - Metric offset-ring wrenches





Standards:

NF ISO 1711-1, NF ISO 691, ISO 1711-1, ISO 691, DIN 838, DIN ISO 1711-1, DIN ISO 691

Description:

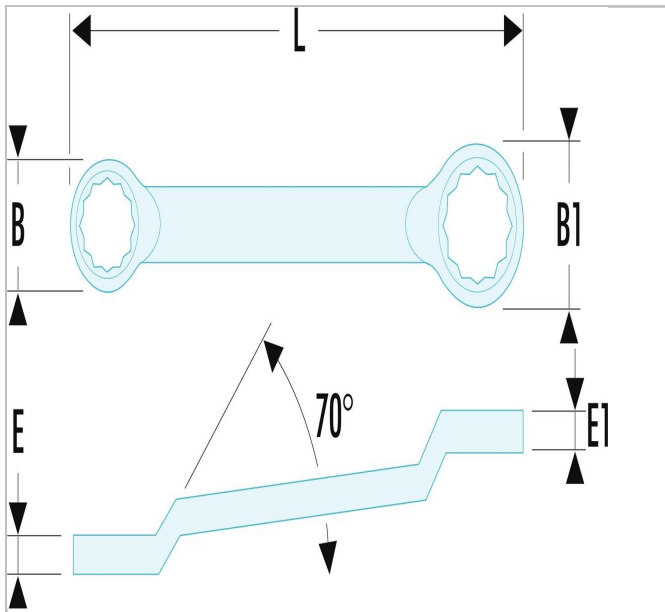
- Offset-ring wrenches: ring offset to clear fingers or obstacles. Ideal for series of nuts.
- OGV® profile with 12-point profile for powerful tightening while protecting the nut.
- Metric sizes: 6 to 50 mm.
- Presentation: satin chrome finish.



	55A.8X10
A [mm]	8x10
Length L [mm]	182.0
Thickness E [mm]	6.5
Thickness E1 [mm]	7.2
Head Width B [mm]	13.7
Head Width B1 [mm]	15.5